

Escala Gráfica en cm.

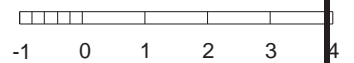

NOTA	DIBUJADO	FECHA	NOMBRE Y APELLIDOS
<b>LAMINA Nº 1</b>			



PLANTA

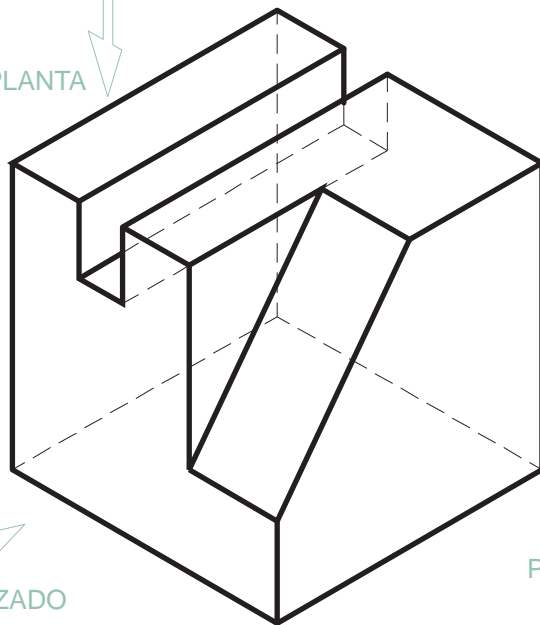

Escala Gráfica en cm.

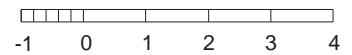

ALZADO

PERFIL

NOTA	DIBUJADO	FECHA	NOMBRE Y APELLIDOS
<b>LAMINA Nº 2</b>			



PLANTA



ALZADO

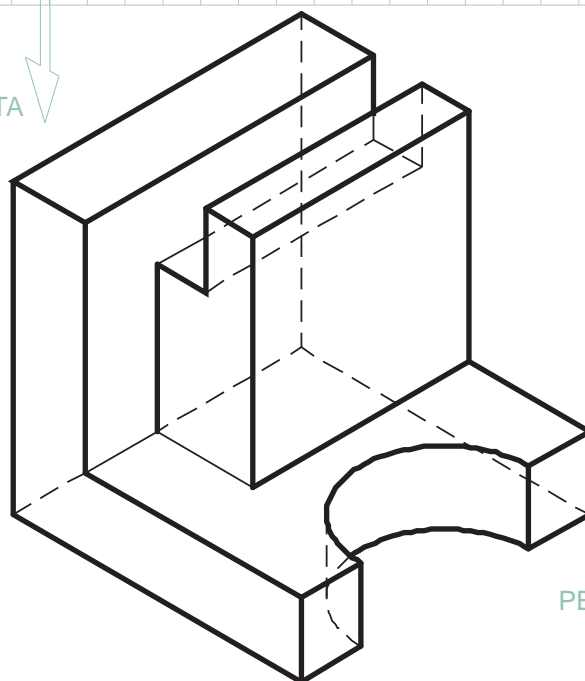

PERFIL



Escala Gráfica en cm.

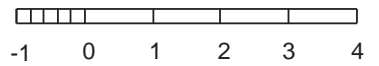

NOTA	DIBUJADO	FECHA	NOMBRE Y APELLIDOS
<b>LAMINA Nº 3</b>			

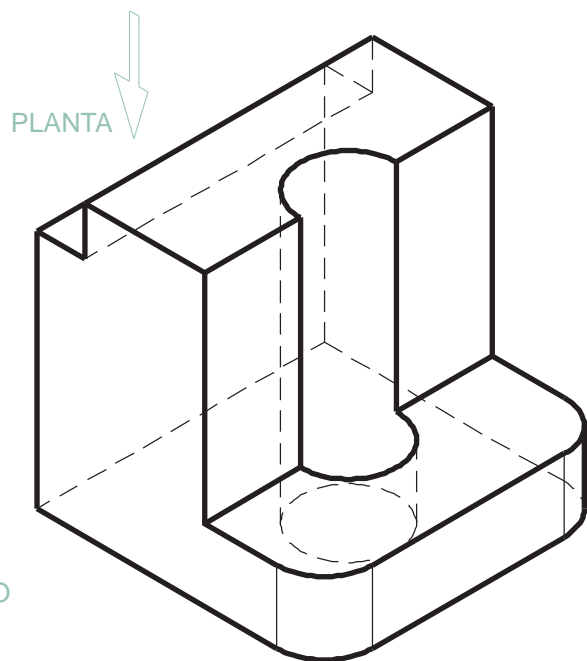

Escala Gráfica en cm.

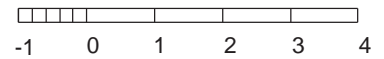

NOTA	DIBUJADO	FECHA	NOMBRE Y APELLIDOS
<b>LAMINA N° 4</b>			

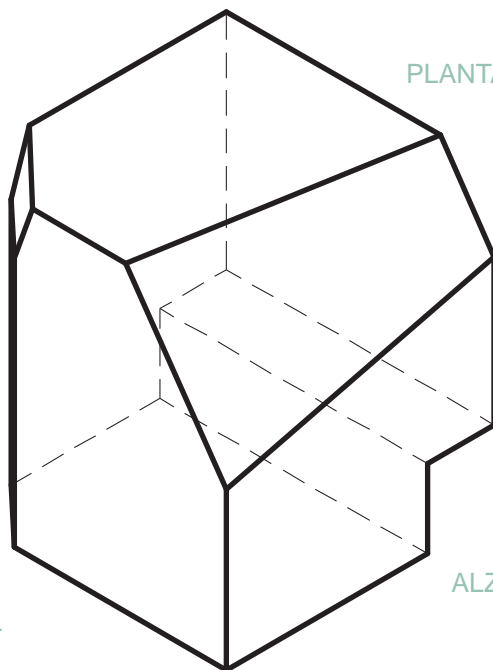
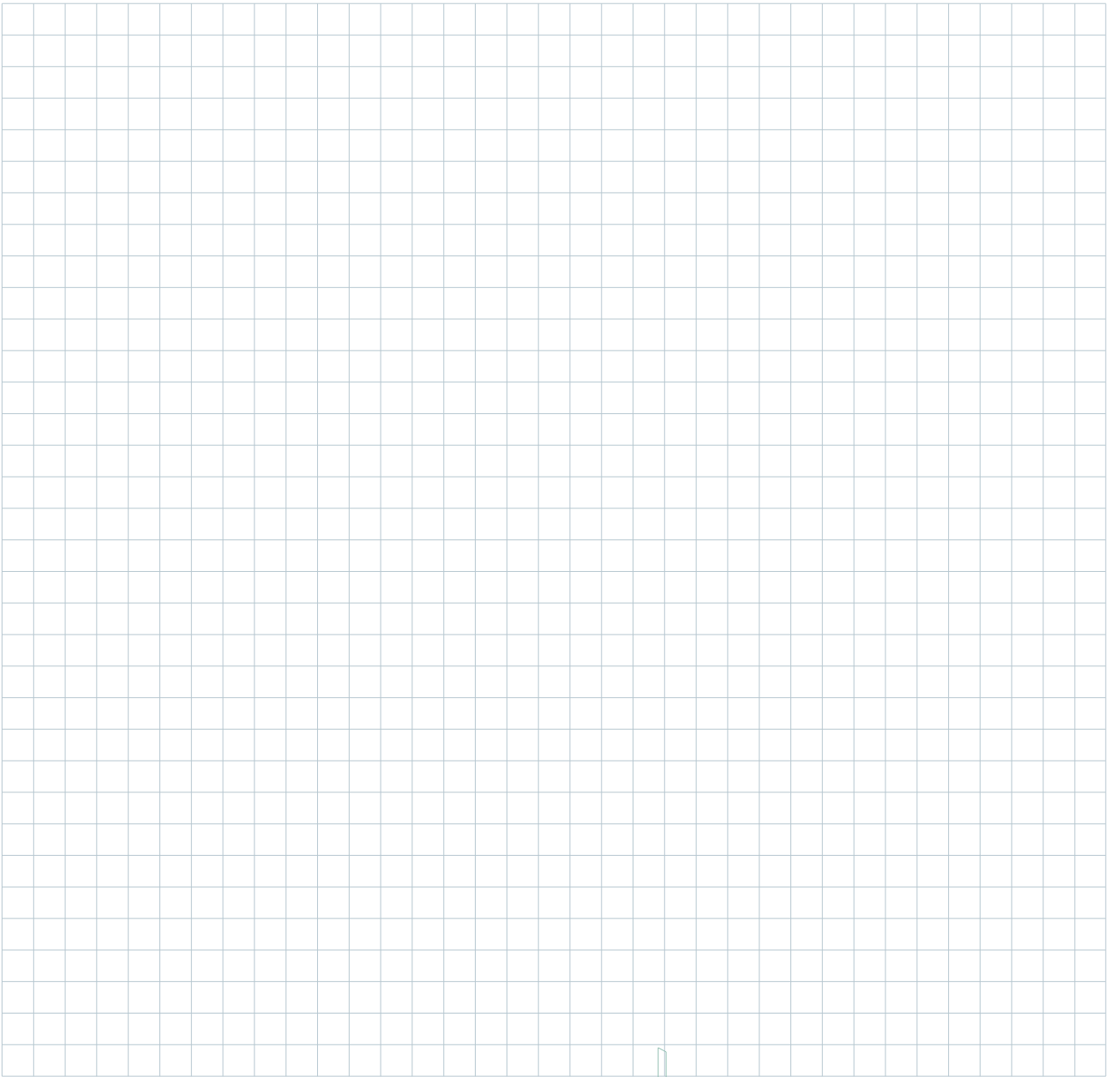

PLANTA



Escala Gráfica en cm.

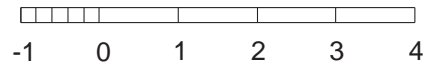

PERFIL



ALZADO

NOTA	DIBUJADO	FECHA	NOMBRE Y APELLIDOS
<b>LAMINA N° 5</b>			

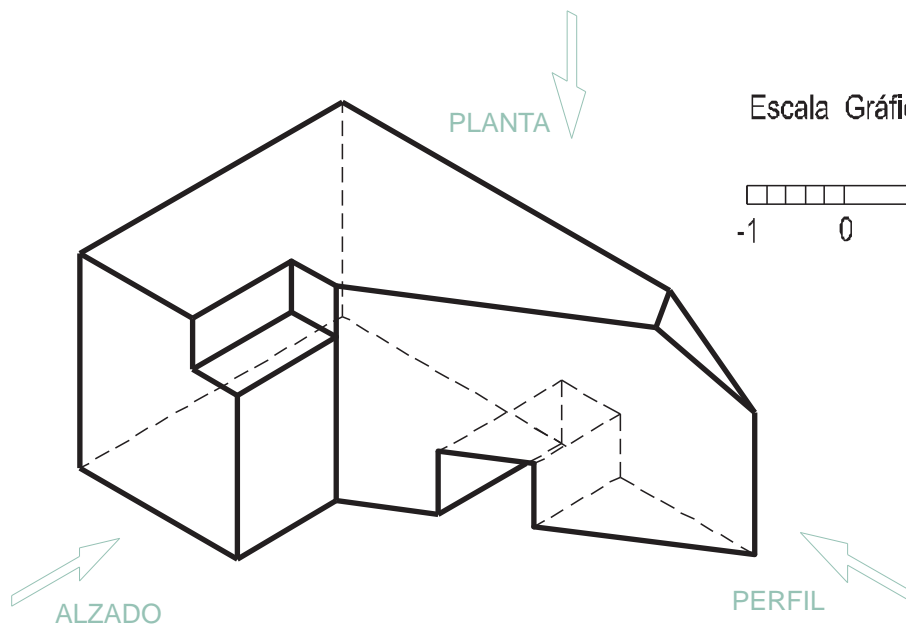
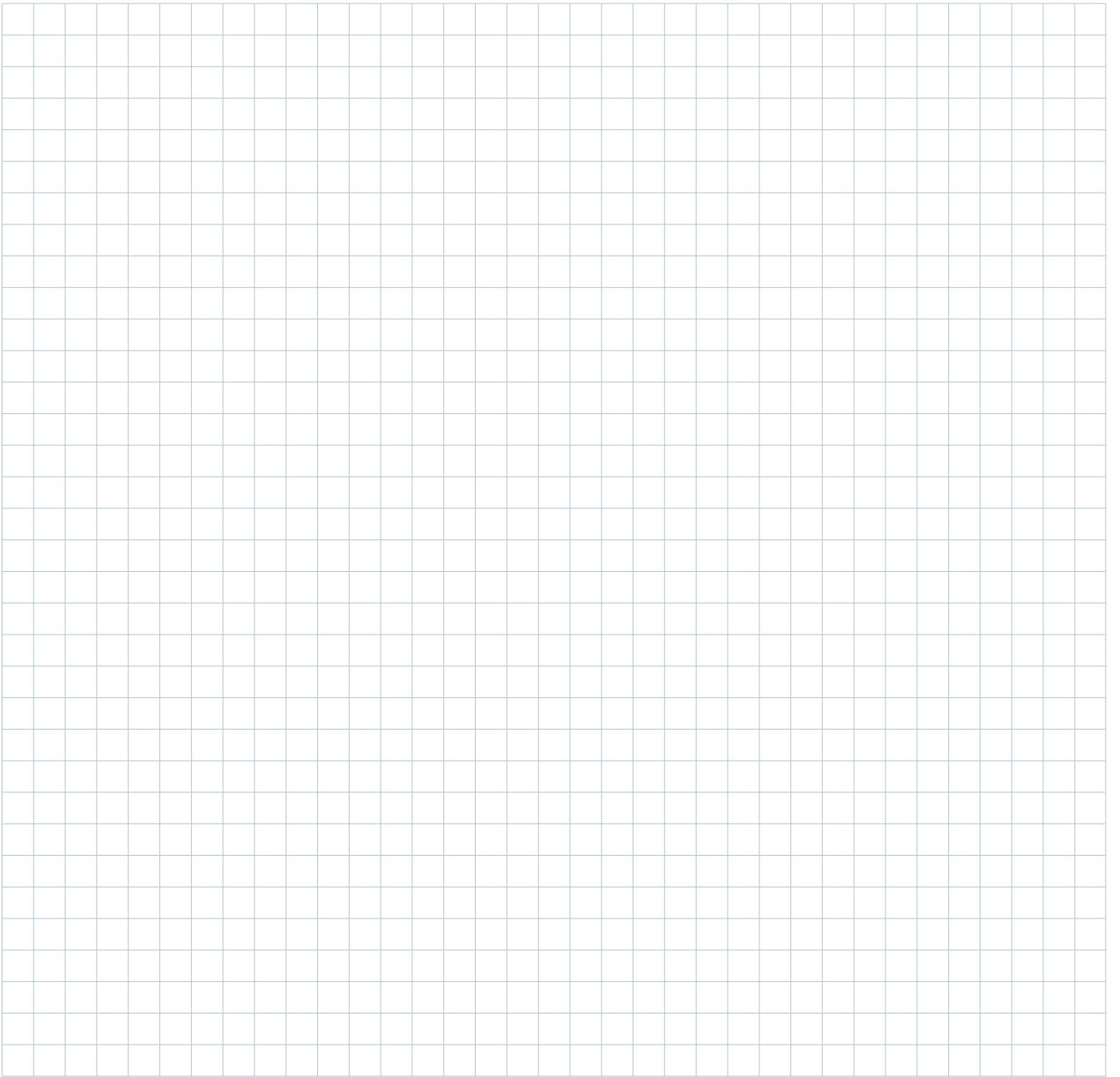

Escala Gráfica en cm.

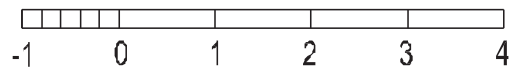

NOTA	DIBUJADO	FECHA	NOMBRE Y APELLIDOS
<b>LAMINA N° 6</b>			

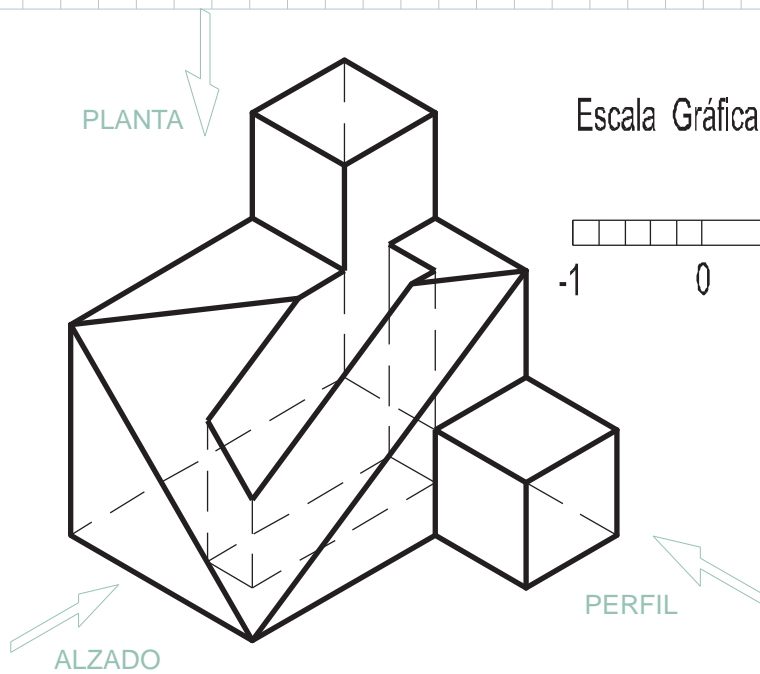

Escala Gráfica en cm.

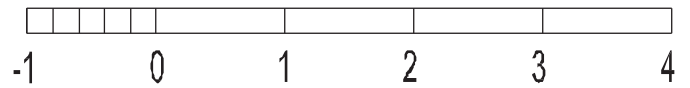

NOTA	DIBUJADO	FECHA	NOMBRE Y APELLIDOS
<b>LÁMINA N° 7</b>			

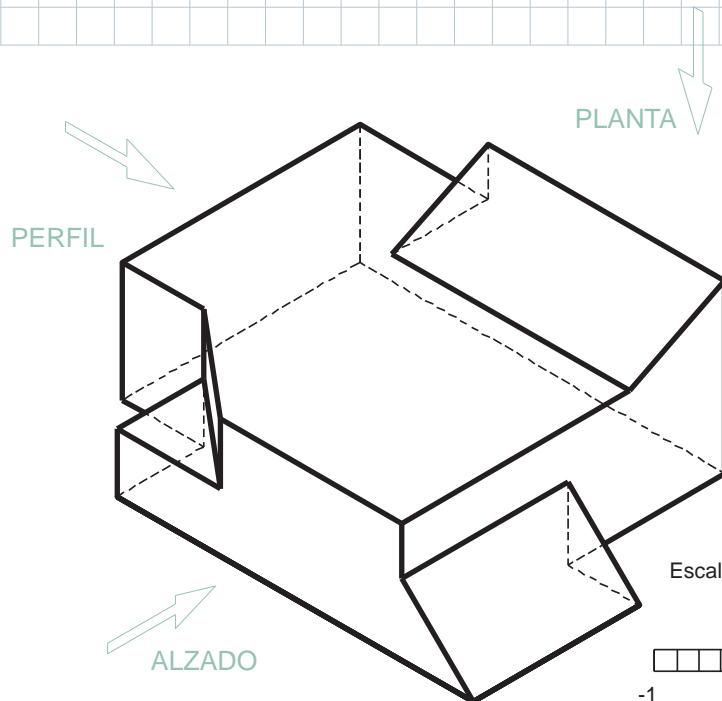

Escala Gráfica en cm.

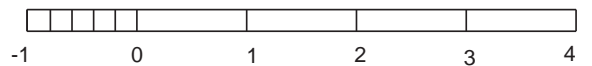

NOTA	DIBUJADO	FECHA	NOMBRE Y APELLIDOS
<b>LÁMINA N° 8</b>			