

Escala Gráfica en cm.

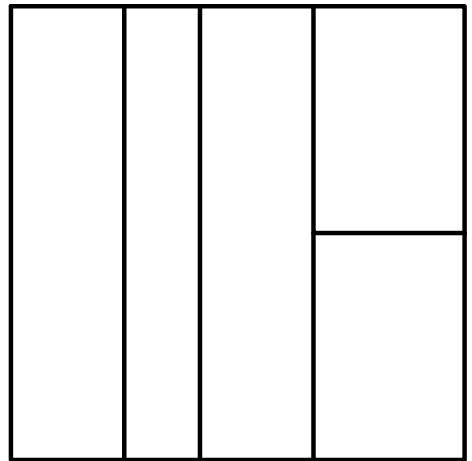

NOTA	DIBUJADO	FECHA	NOMBRE APELLIDOS
LAMINA Nº 1			

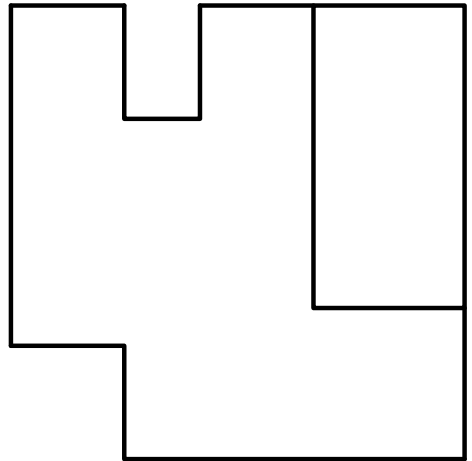
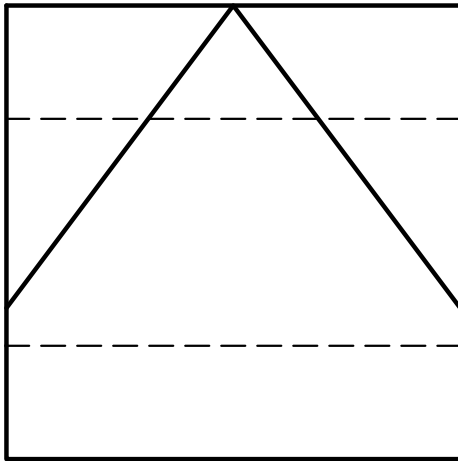
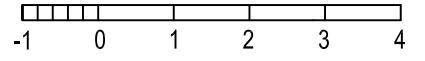
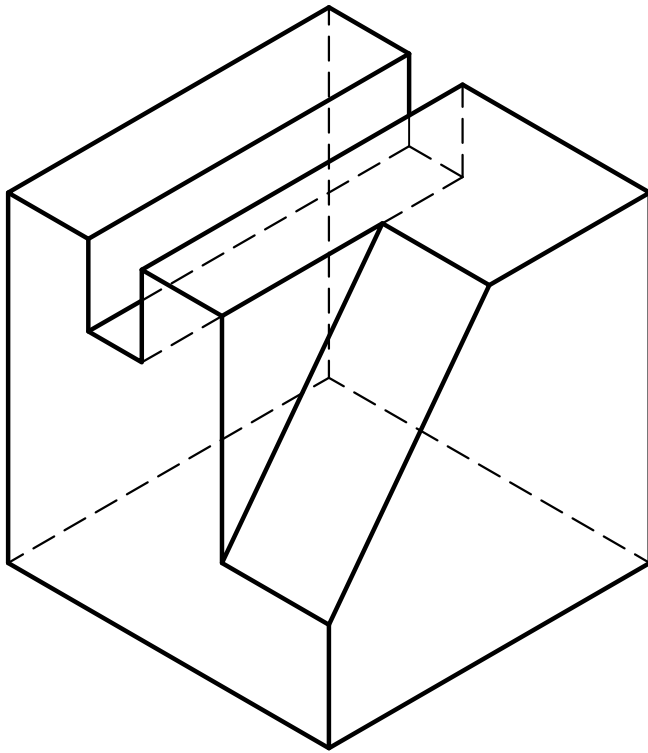

Escala Gráfica en cm.

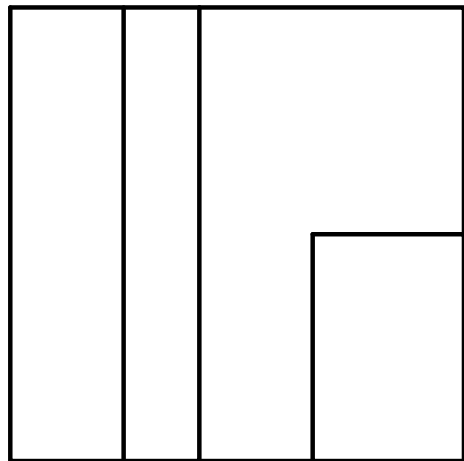
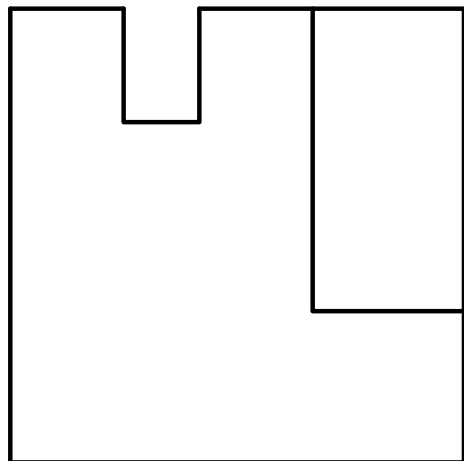
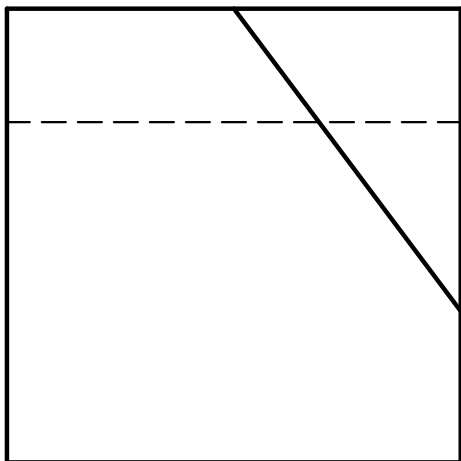
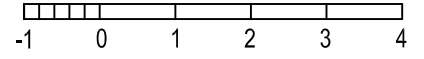

NOTA	DIBUJADO	FECHA	NOMBRE APELLIDOS
LAMINA Nº 2			

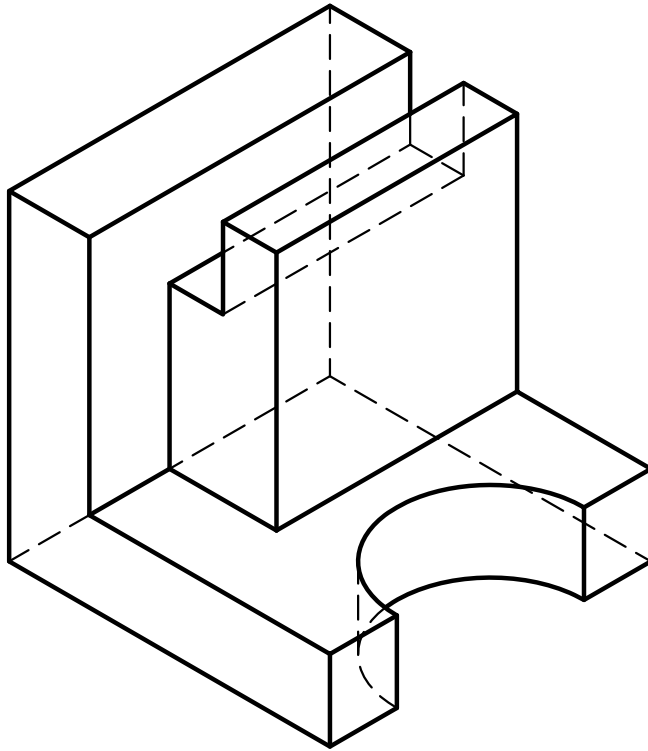

Escala Gráfica en cm.

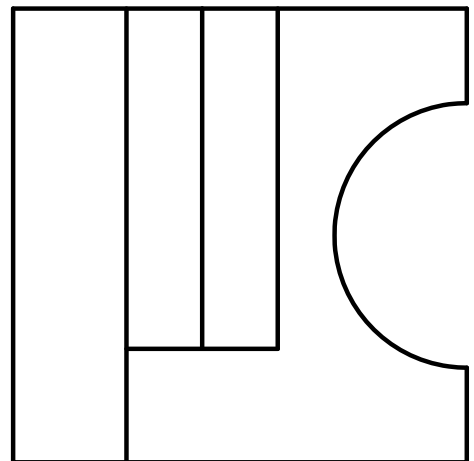
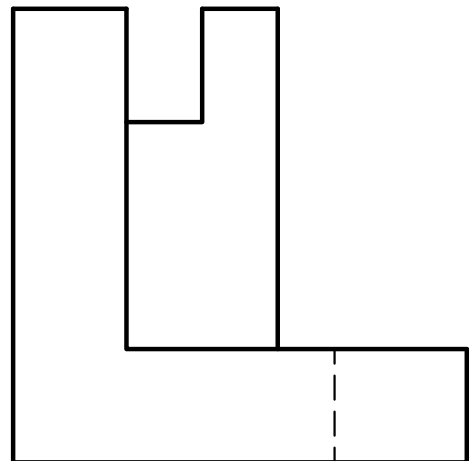
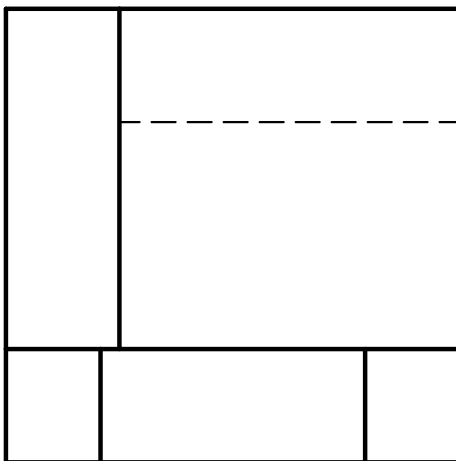
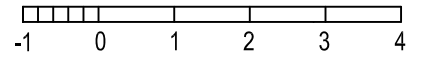

NOTA	DIBUJADO	FECHA	NOMBRE APELLIDOS
LAMINA N° 3			

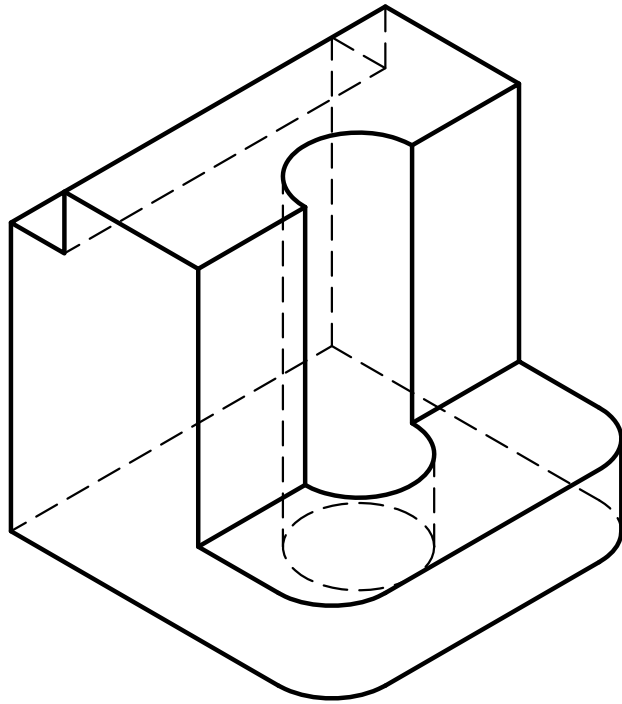

Escala Gráfica en cm.

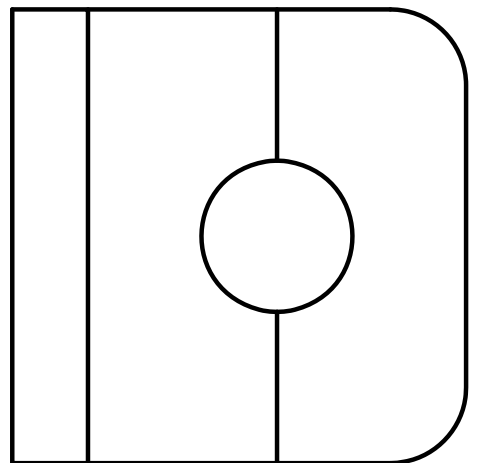
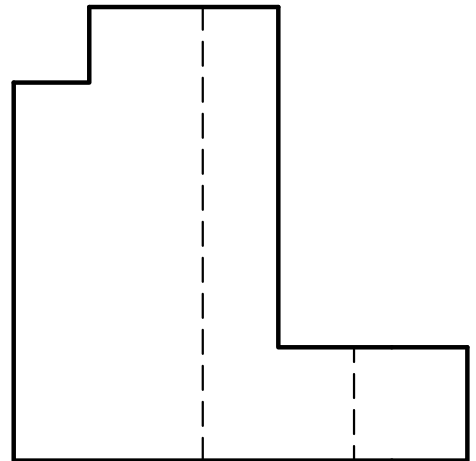
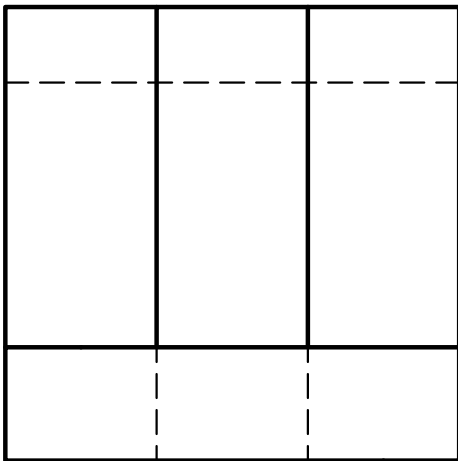
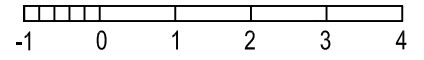

NOTA	DIBUJADO	FECHA	NOMBRE APELLIDOS
LAMINA Nº 4			

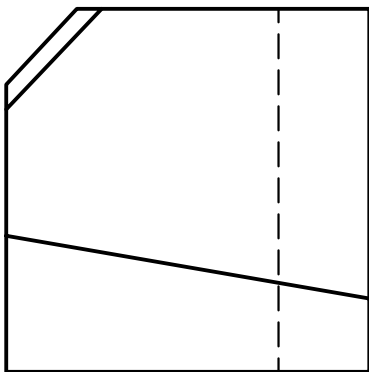
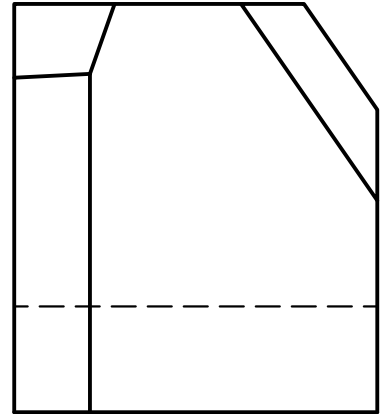
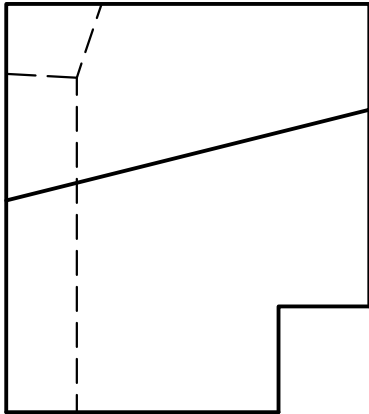
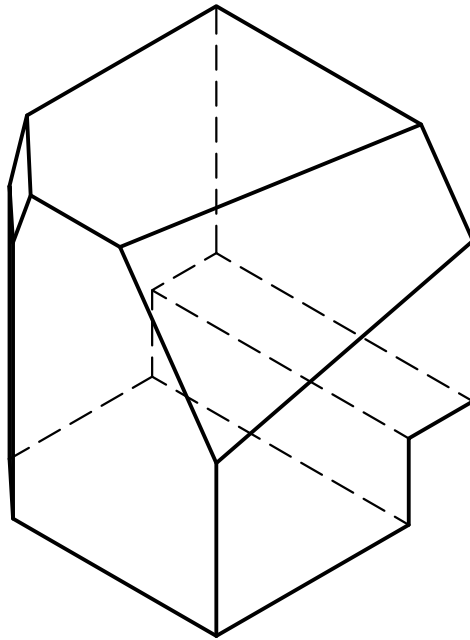

NOTA	DIBUJADO	FECHA	NOMBRE APELLIDOS	
LAMINA N° 5				

Escala Gráfica en cm.

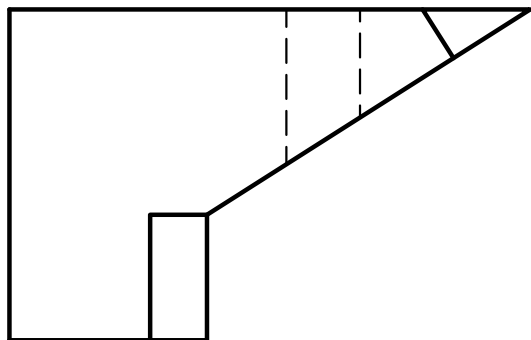
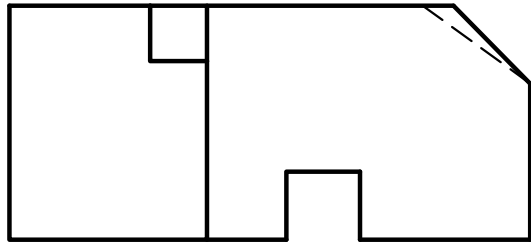
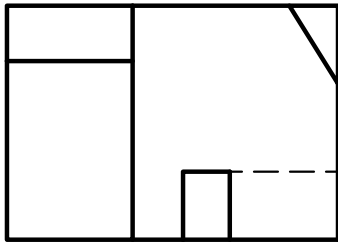
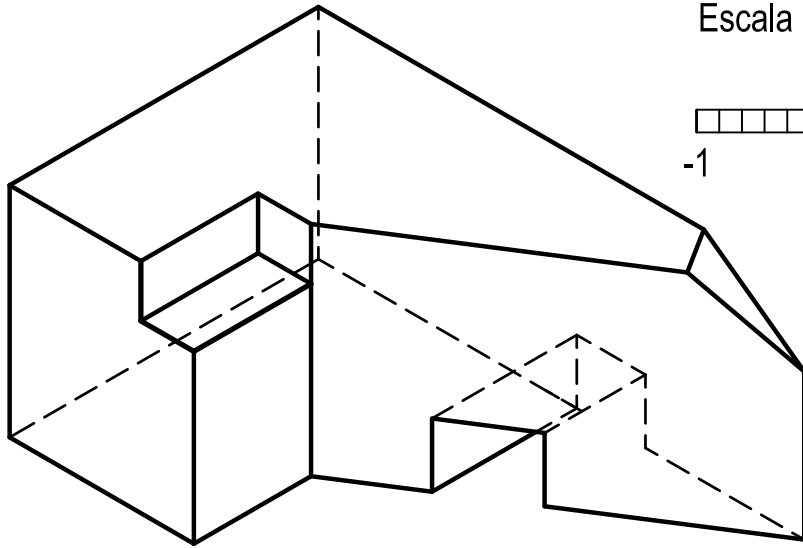
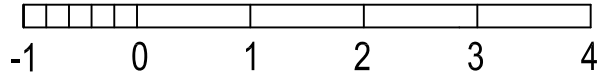

NOTA	DIBUJADO	FECHA	NOMBRE APELLIDOS
LAMINA N° 6			

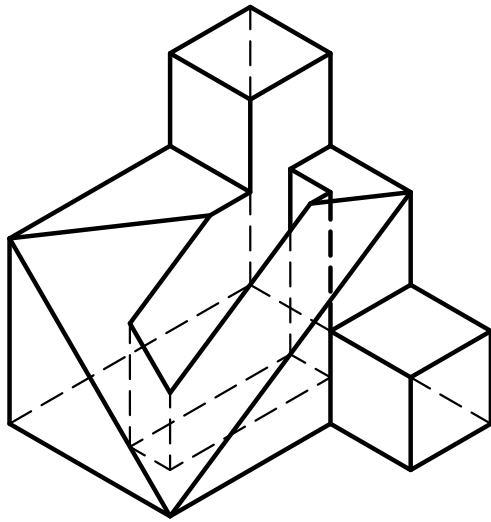

Escala Gráfica en cm.

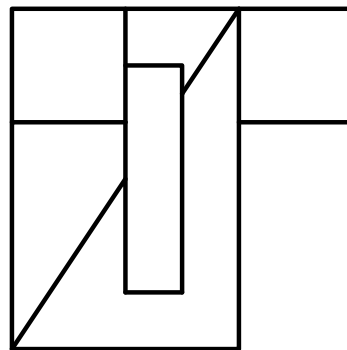
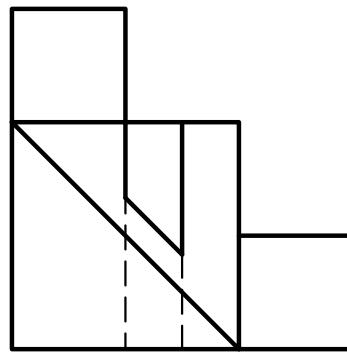
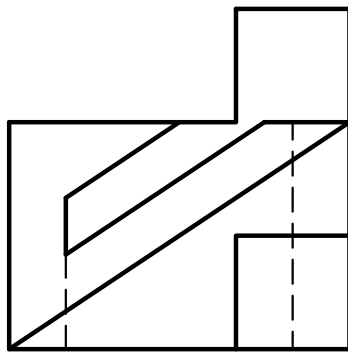
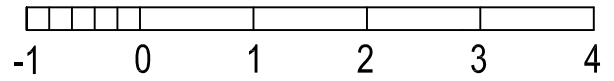

NOTA	DIBUJADO	FECHA	NOMBRE APELLIDOS
LAMINA Nº 7			

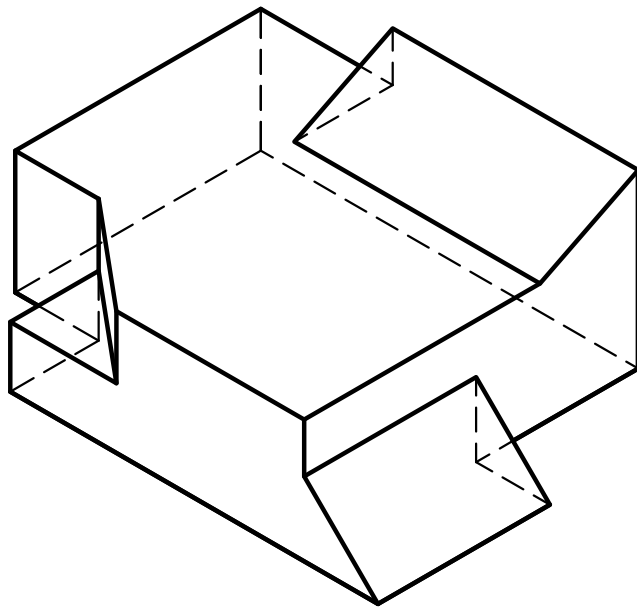

Escala Gráfica en cm.

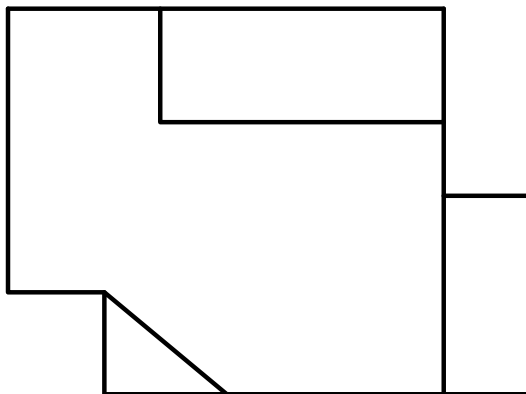
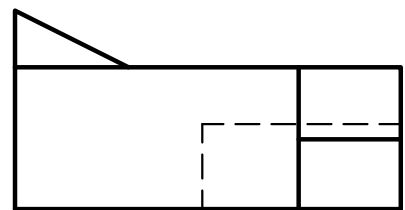
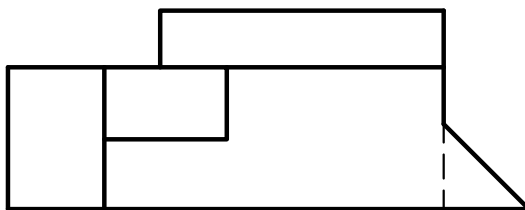
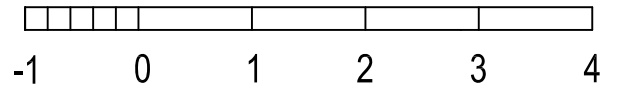

NOTA	DIBUJADO	FECHA	NOMBRE APELLIDOS
LAMINA Nº 8			